

# play in motion

“ready-made for the trade”



**2.0m - 1 Cradle Seat**

L: 2610 W: 1424 H: 2138mm  
 Min Surface Area: 6.05 x 1.75m (10.6m<sup>2</sup>)  
 Min Space: 6.05 x 2.61m FFH: 1.2m

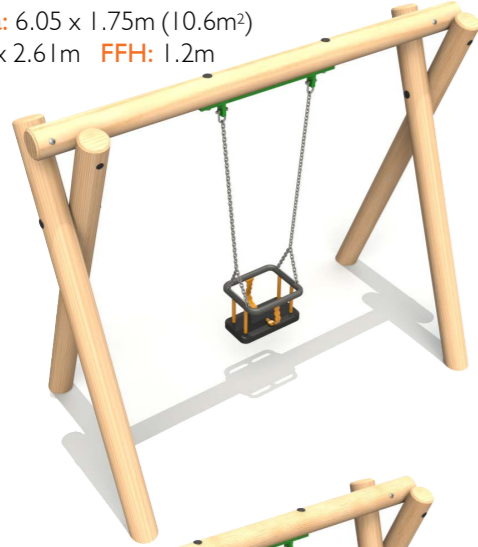

**2.4m - 1 Flat Seat**

L: 2610 W: 1730 H: 2538mm  
 Min Surface Area: 6.7 x 1.75m (11.7m<sup>2</sup>)  
 Min Space: 6.7 x 2.61m FFH: 1.4m

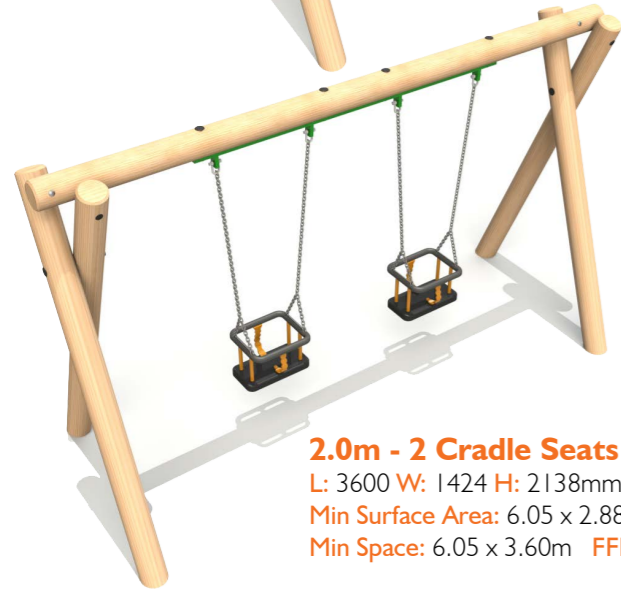

**2.0m - 2 Cradle Seats**

L: 3600 W: 1424 H: 2138mm  
 Min Surface Area: 6.05 x 2.88m (17.4m<sup>2</sup>)  
 Min Space: 6.05 x 3.60m FFH: 1.2m



**2.4m - 2 Flat Seats**

L: 3600 W: 1730 H: 2538mm  
 Min Surface Area: 6.7 x 2.88m (19.3m<sup>2</sup>)  
 Min Space: 6.7 x 3.60m FFH: 1.4m

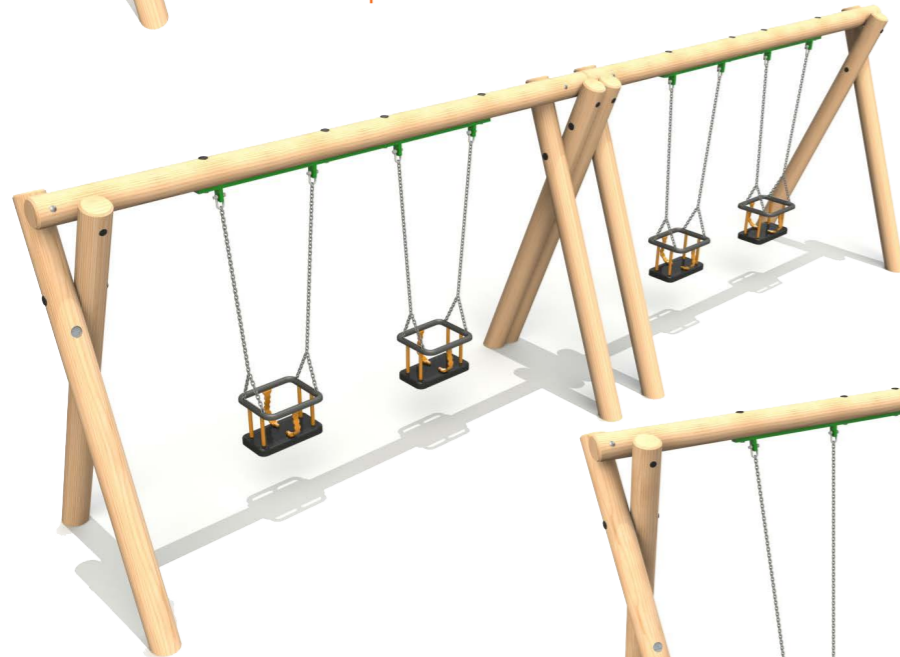

**2.0m - 4 Cradle Seats**

L: 7200 W: 1424 H: 2138mm  
 Min Surface Area: 6.05 x 5.76m (34.8m<sup>2</sup>)  
 Min Space: 7.2 x 6.05m FFH: 1.2m



**2.4m - 4 Flat Seats**

L: 7200 W: 1730 H: 2538mm  
 Min Surface Area: 6.7 x 5.76m (38.59m<sup>2</sup>)  
 Min Space: 7.2 x 6.7m FFH: 1.4m

**2.4m - 2 Flat & 1 Cradle Seats**

L: 6210 W: 1730 H: 2538mm  
 Min Surface Area: 6.7 x 4.63m (31.02m<sup>2</sup>)  
 Min Space: 6.7 x 6.2m FFH: 1.4m

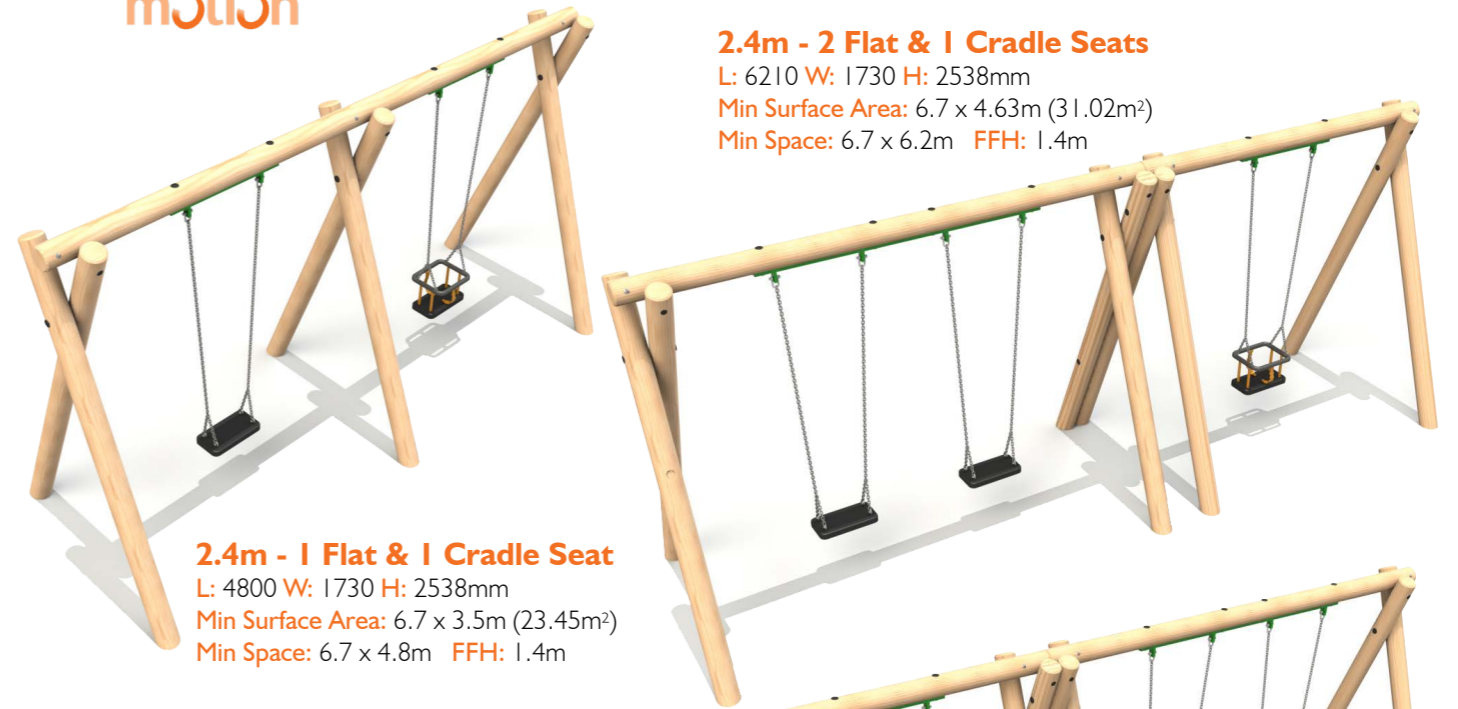

**2.4m - 1 Flat & 1 Cradle Seat**

L: 4800 W: 1730 H: 2538mm  
 Min Surface Area: 6.7 x 3.5m (23.45m<sup>2</sup>)  
 Min Space: 6.7 x 4.8m FFH: 1.4m



**2.4m - 1 Inclusive Seat**

L: 2742 W: 1730 H: 2538mm  
 Min Surface Area: 7 x 1.8m (12.6m<sup>2</sup>)  
 Min Space: 7 x 2.61m FFH: 1.4m

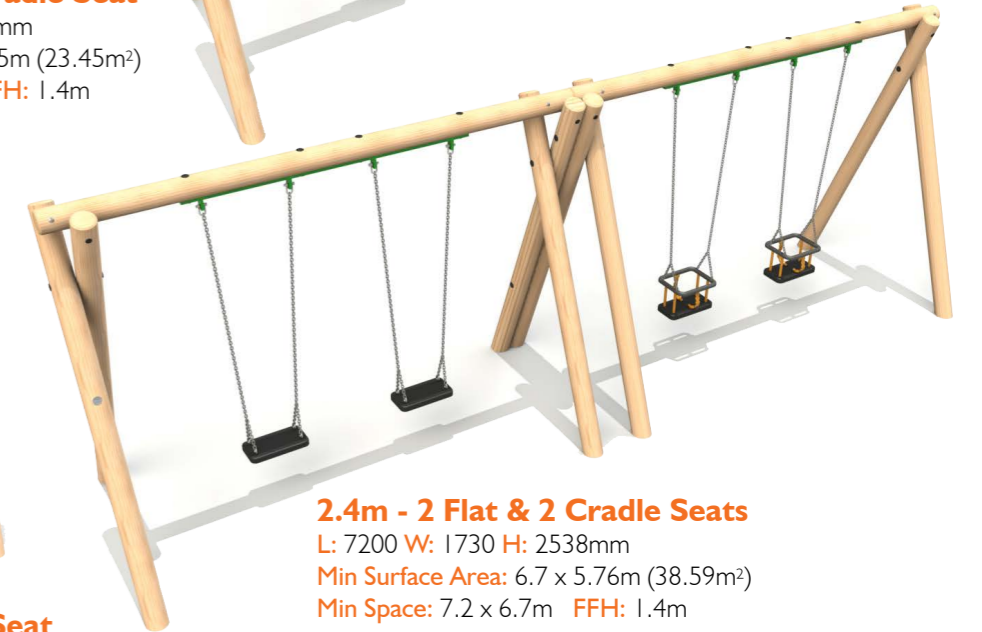

**2.4m - 2 Flat & 2 Cradle Seats**

L: 7200 W: 1730 H: 2538mm  
 Min Surface Area: 6.7 x 5.76m (38.59m<sup>2</sup>)  
 Min Space: 7.2 x 6.7m FFH: 1.4m



**2.4m - 1 Inclusive & 1 Cradle Seat**

L: 3600 W: 1730 H: 2538mm  
 Min Surface Area: 7 x 2.93m (20.51m<sup>2</sup>)  
 Min Space: 7 x 3.60m FFH: 1.4m



**2.4m - 1 Inclusive & 1 Flat Seat**

L: 3600 W: 1730 H: 2538mm  
 Min Surface Area: 7 x 2.93m (20.51m<sup>2</sup>)  
 Min Space: 7 x 3.60m FFH: 1.4m



**Steel feet**

Galvanised steel feet can be fitted on all timber swings for a small additional charge. Steel feet offer an alternative to in-ground timbers and can be used in both wet pour and extended for loose fill surfacing.

**2.4m Timber Group Swing**

L: 3600 W: 1730 H: 2538mm  
 Min Surface Area: 7 x 3m (21m<sup>2</sup>)  
 Min Space: 7 x 3.60m FFH: 1.4m

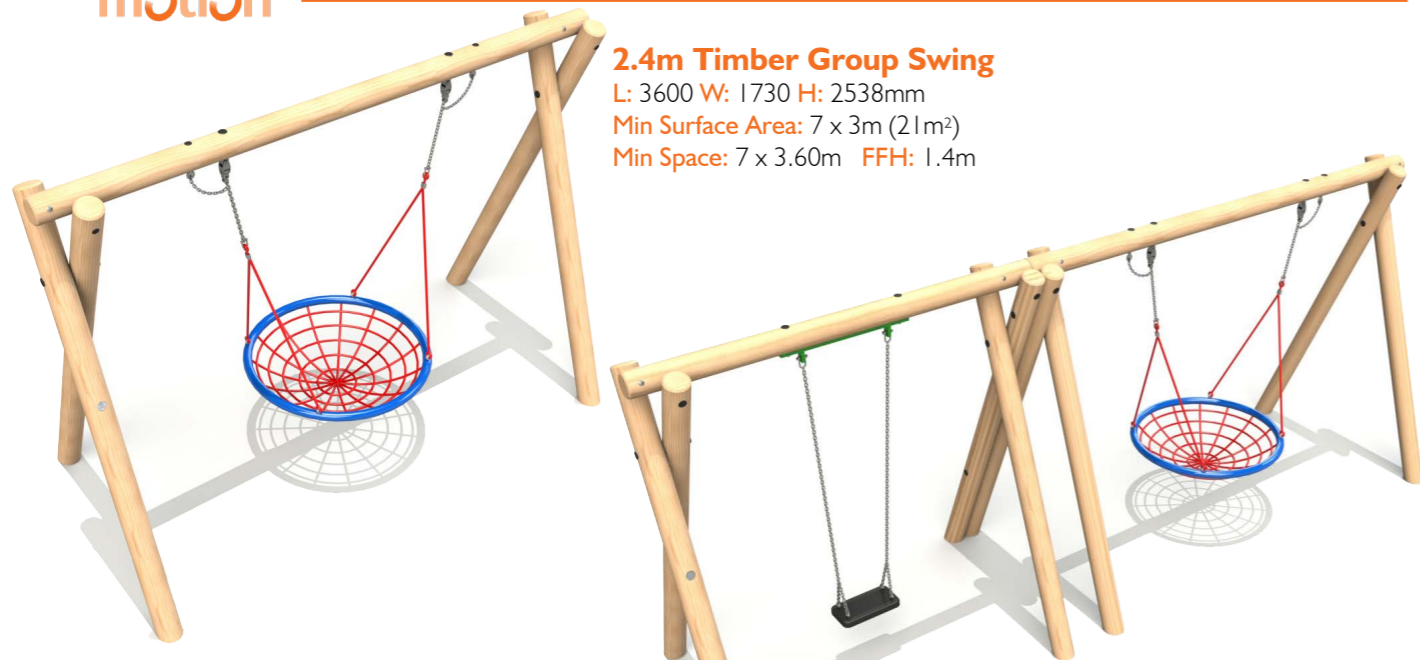

**2.4m - 1 Flat & 1 Group Seat**

L: 6210 W: 1730 H: 2538mm  
 Min Surface Area: 7 x 5m (35m<sup>2</sup>)  
 Min Space: 6.22 x 7m FFH: 1.4m

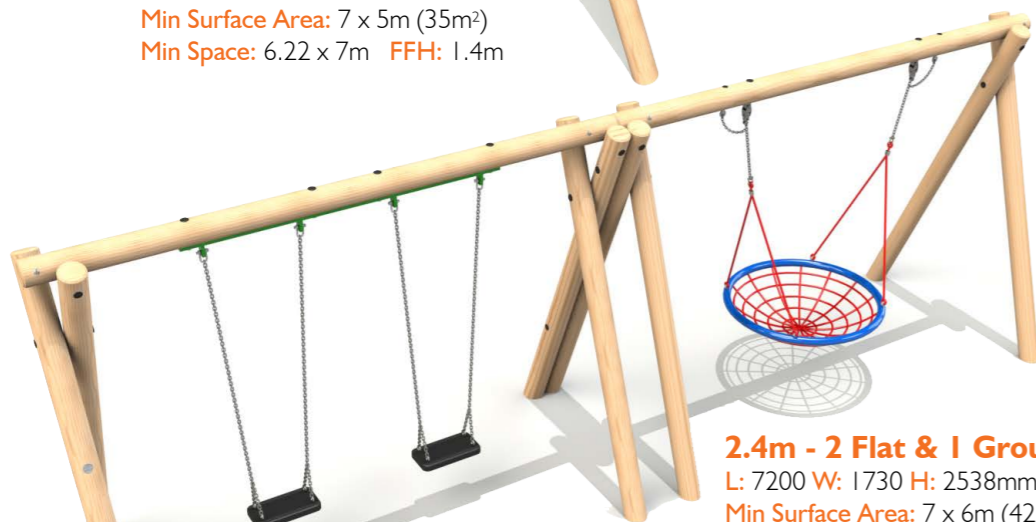

**2.4m - 2 Flat & 1 Group Seat**

L: 7200 W: 1730 H: 2538mm  
 Min Surface Area: 7 x 6m (42m<sup>2</sup>)  
 Min Space: 7.2 x 7m FFH: 1.4m

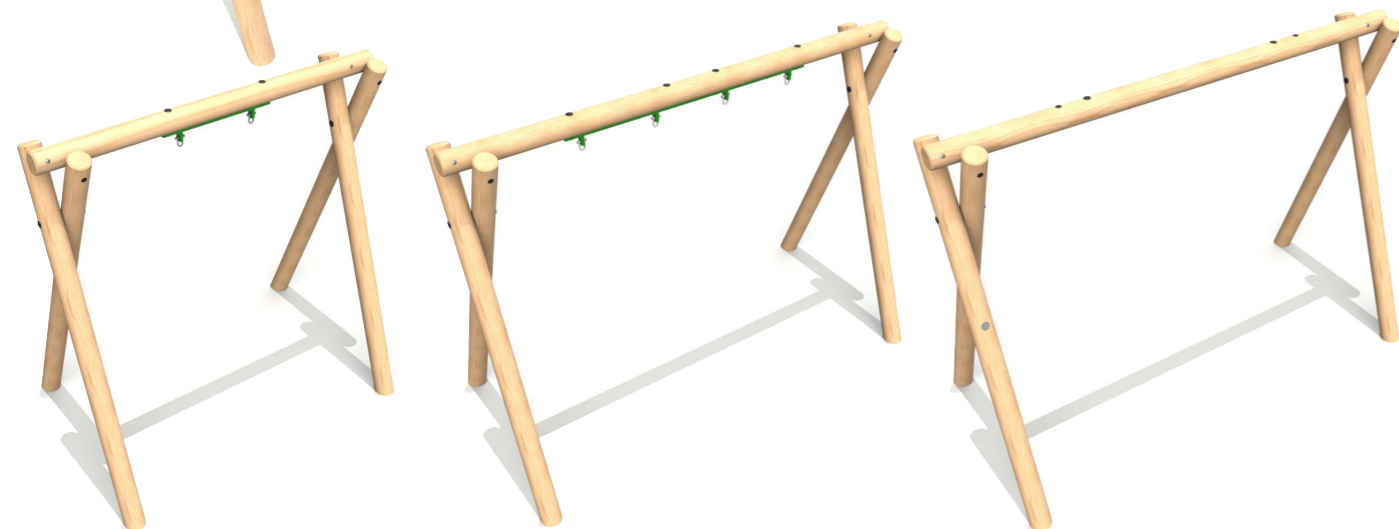

**Timber Swing Frames available without seats and chains.**

Frames come with all fixings and swing seat hangers. Universal joints and safety chains are not included with the group seat frames.

Steel Feet options Available, more details and prices are available upon request

**Six Seat Hexagonal Swing**

L: 7040 W: 6139 H: 2620mm  
 Min Surface Area: 12.6 x 11.8m (58.3m<sup>2</sup>)  
 Min Space: 13.12 x 12.24m FFH: 1.4m



**2.35m Crocodile Swing**

L: 3000 W: 2800 H: 2820mm  
 Min Surface Area: 8.53 x 3.2m (25.2m<sup>2</sup>)  
 Min Space: 8.53 x 3.15m FFH: 1.5m  
 Includes steel feet as standard

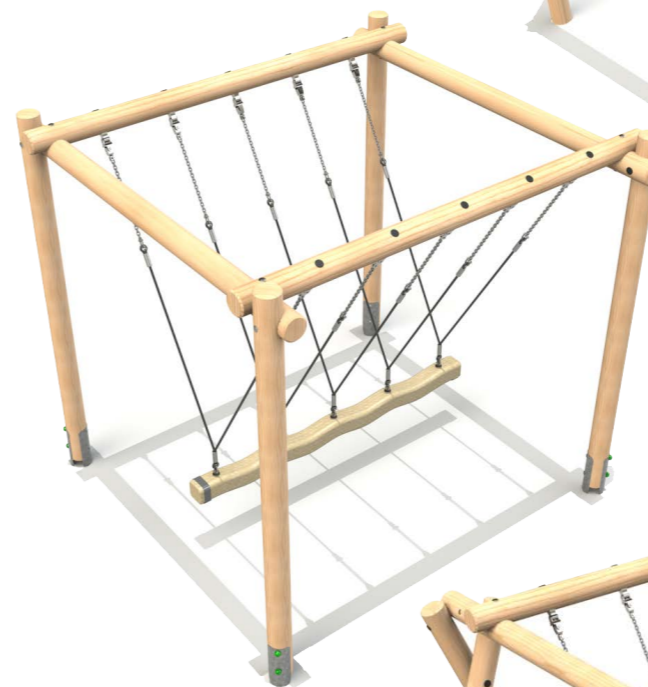

**3.35m Crocodile Swing also available**

**4.85m Crocodile Swing**

L: 6977 W: 3420 H: 2805mm  
 Min Surface Area: 11.3 x 3.15m (33.91m<sup>2</sup>)  
 Min Space: 11.31 x 3.42m FFH: 1.5m  
 Includes steel feet as standard



**Steel feet**

Galvanised steel feet can be fitted on all timber swings for a small additional charge. Steel feet offer an alternative to in-ground timbers and can be used in both wet pour and extended for loose fill surfacing.

Bespoke units available on request

**2.0m - 1 Cradle Seat**

L: 2660 W: 1150 H: 2110mm  
 Min Surface Area: 6.05 x 1.75m (10.6m<sup>2</sup>)  
 Min Space: 6.05 x 2.66m FFH: 1.2m



**2.4m - 1 Flat Seat**

L: 2820 W: 1300 H: 2510mm  
 Min Surface Area: 6.7 x 1.75m (11.72m<sup>2</sup>)  
 Min Space: 6.7 x 2.82m FFH: 1.4m



**2.0m - 2 Cradle Seats**

L: 3780 W: 1150 H: 2110mm  
 Min Surface Area: 6.05 x 2.88m (17.4m<sup>2</sup>)  
 Min Space: 6.05 x 3.92m FFH: 1.2m

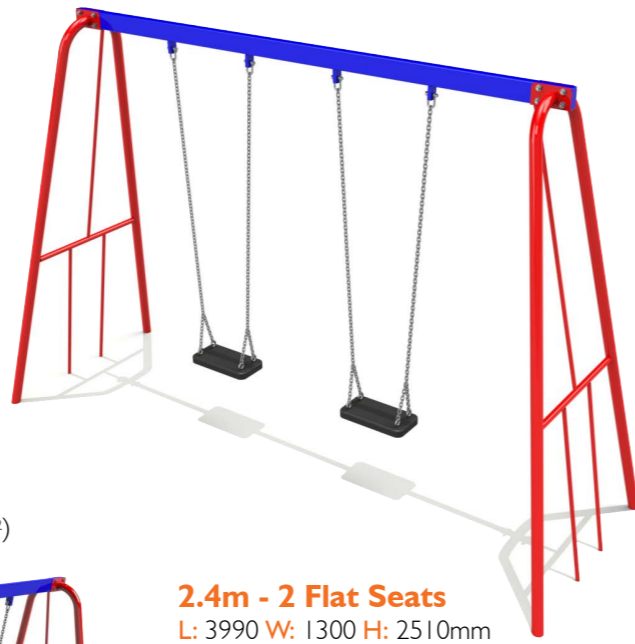

**2.4m - 2 Flat Seats**

L: 3990 W: 1300 H: 2510mm  
 Min Surface Area: 6.7 x 2.88m (19.3m<sup>2</sup>)  
 Min Space: 6.7 x 3.99m FFH: 1.4m

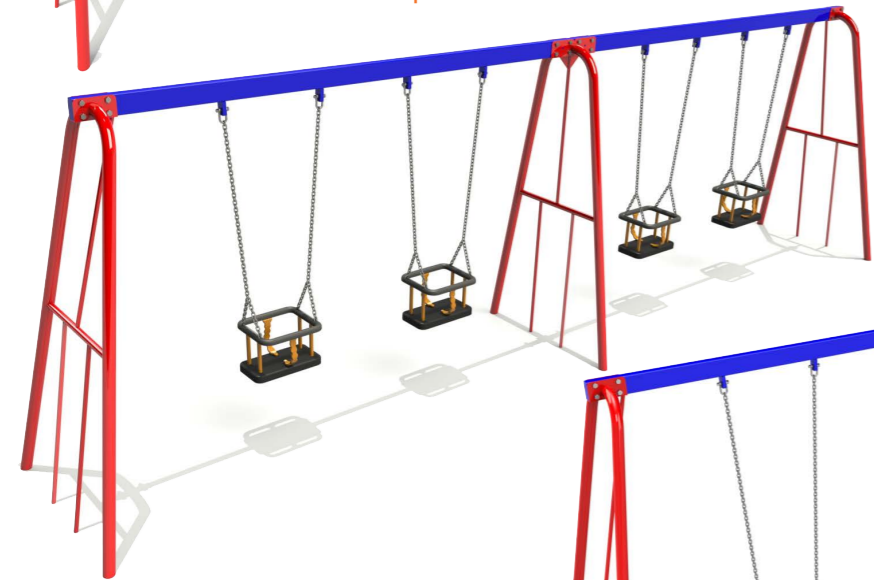

**2.0m - 4 Cradle Seats**

L: 6980 W: 1150 H: 2110mm  
 Min Surface Area: 6.05 x 5.76m (34.8m<sup>2</sup>)  
 Min Space: 6.98 x 6.05m FFH: 1.2m

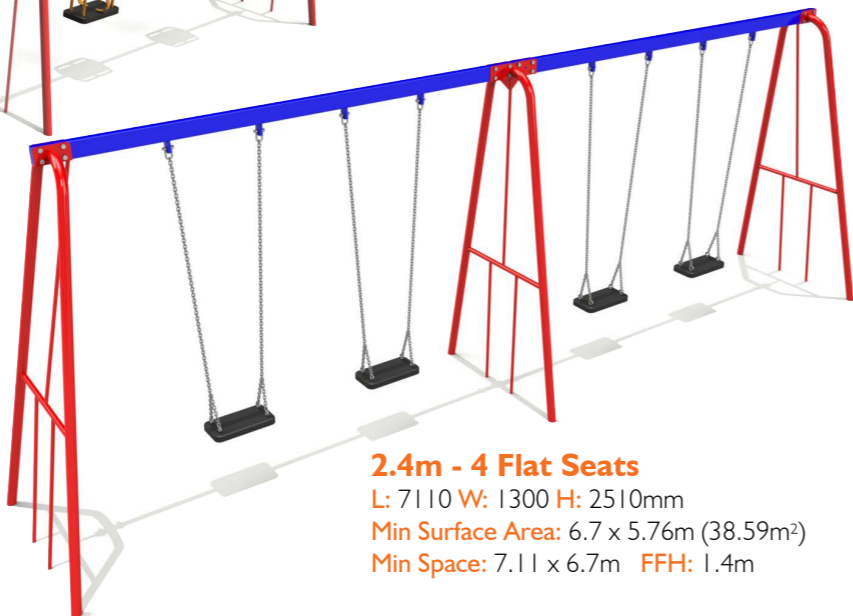

**2.4m - 4 Flat Seats**

L: 7110 W: 1300 H: 2510mm  
 Min Surface Area: 6.7 x 5.76m (38.59m<sup>2</sup>)  
 Min Space: 7.11 x 6.7m FFH: 1.4m

Other steel colours are available upon request

**2.4m - 1 Flat & 1 Cradle Seat**

L: 4880 W: 1300 H: 2510mm  
 Min Surface Area: 6.7 x 3.5m (23.45m<sup>2</sup>)  
 Min Space: 6.7 x 4.87m FFH: 1.4m



**2.4m - 2 Flat & 1 Cradle Seats**

L: 5980 W: 1300 H: 2510mm  
 Min Surface Area: 6.7 x 4.63m (31.02m<sup>2</sup>)  
 Min Space: 6.7 x 5.98m FFH: 1.4m

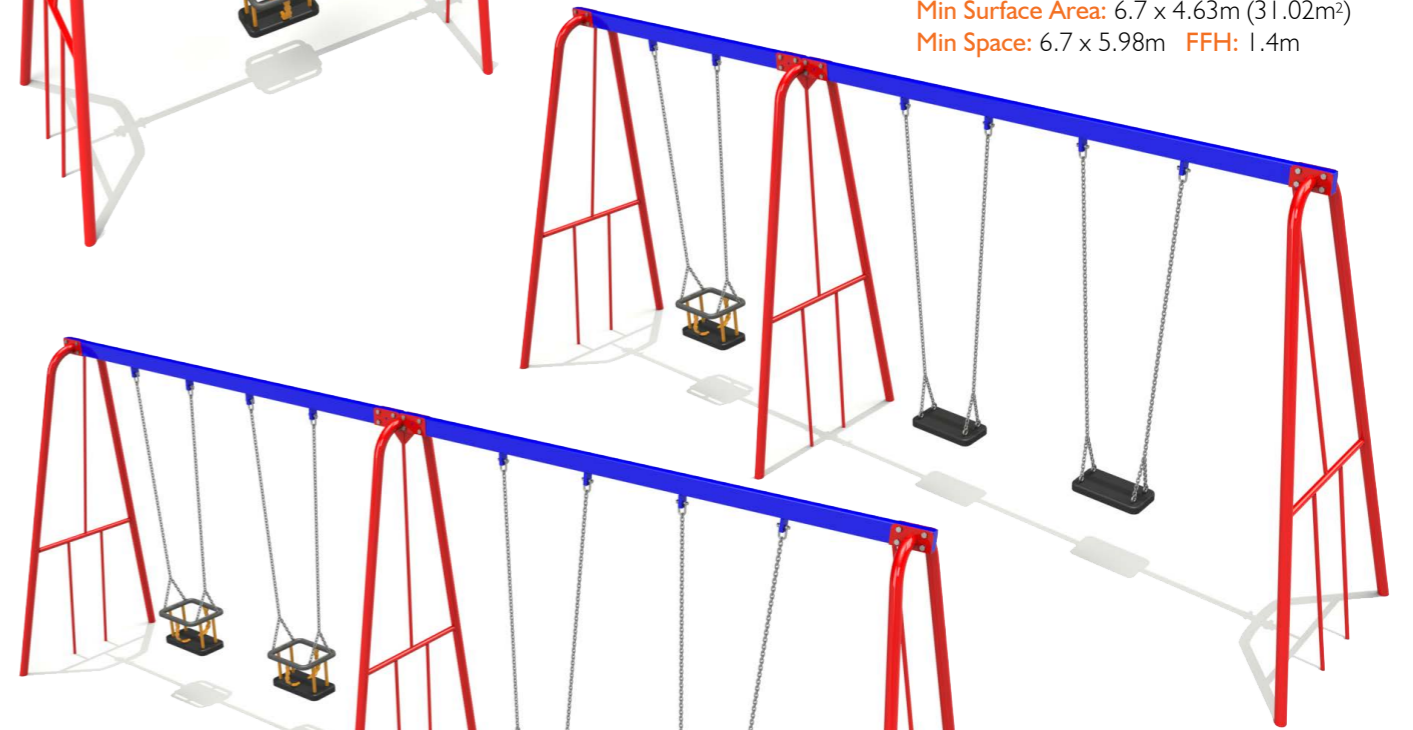

**2.4m - 2 Flat & 2 Cradle Seats**

L: 7110 W: 1300 H: 2510mm  
 Min Surface Area: 6.7 x 5.76m (38.59m<sup>2</sup>)  
 Min Space: 7.11 x 6.7m FFH: 1.4m



**Steel Swing Frames available without seats and chains.**

Frames come with all fixings and swing seat hangers. Universal joints and safety chains are not included with the group seat frames.

Bespoke units available on request



**2.4m - 2 Flat & 1 Group Seat**  
 L: 7110 W: 1300 H: 2510mm  
 Min Surface Area: 7 x 5.88m (41.16m<sup>2</sup>)  
 Min Space: 7.2 x 7m FFH: 1.4m

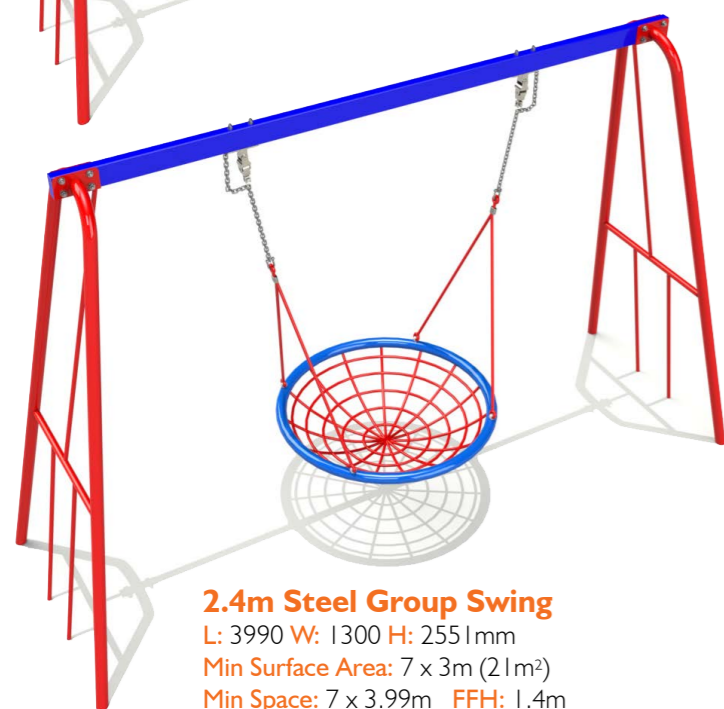

**2.4m Steel Group Swing**  
 L: 3990 W: 1300 H: 2551mm  
 Min Surface Area: 7 x 3m (21m<sup>2</sup>)  
 Min Space: 7 x 3.99m FFH: 1.4m



**2.4m - 1 Inclusive Seat**  
 L: 2820 W: 1300 H: 2510mm  
 Min Surface Area: 7 x 1.8m (12.6m<sup>2</sup>)  
 Min Space: 7 x 2.82m FFH: 1.4m



**2.4m - 1 Inclusive & 1 Cradle Seat**  
 L: 3930 W: 1300 H: 2510mm  
 Min Surface Area: 7 x 2.88m (20.16m<sup>2</sup>)  
 Min Space: 7 x 3.99m FFH: 1.4m



**2.4m - 1 Inclusive & 1 Flat Seat**  
 L: 3930 W: 1300 H: 2510mm  
 Min Surface Area: 7 x 2.88m (20.16m<sup>2</sup>)  
 Min Space: 7 x 3.99m FFH: 1.4m

Other steel colours are available upon request

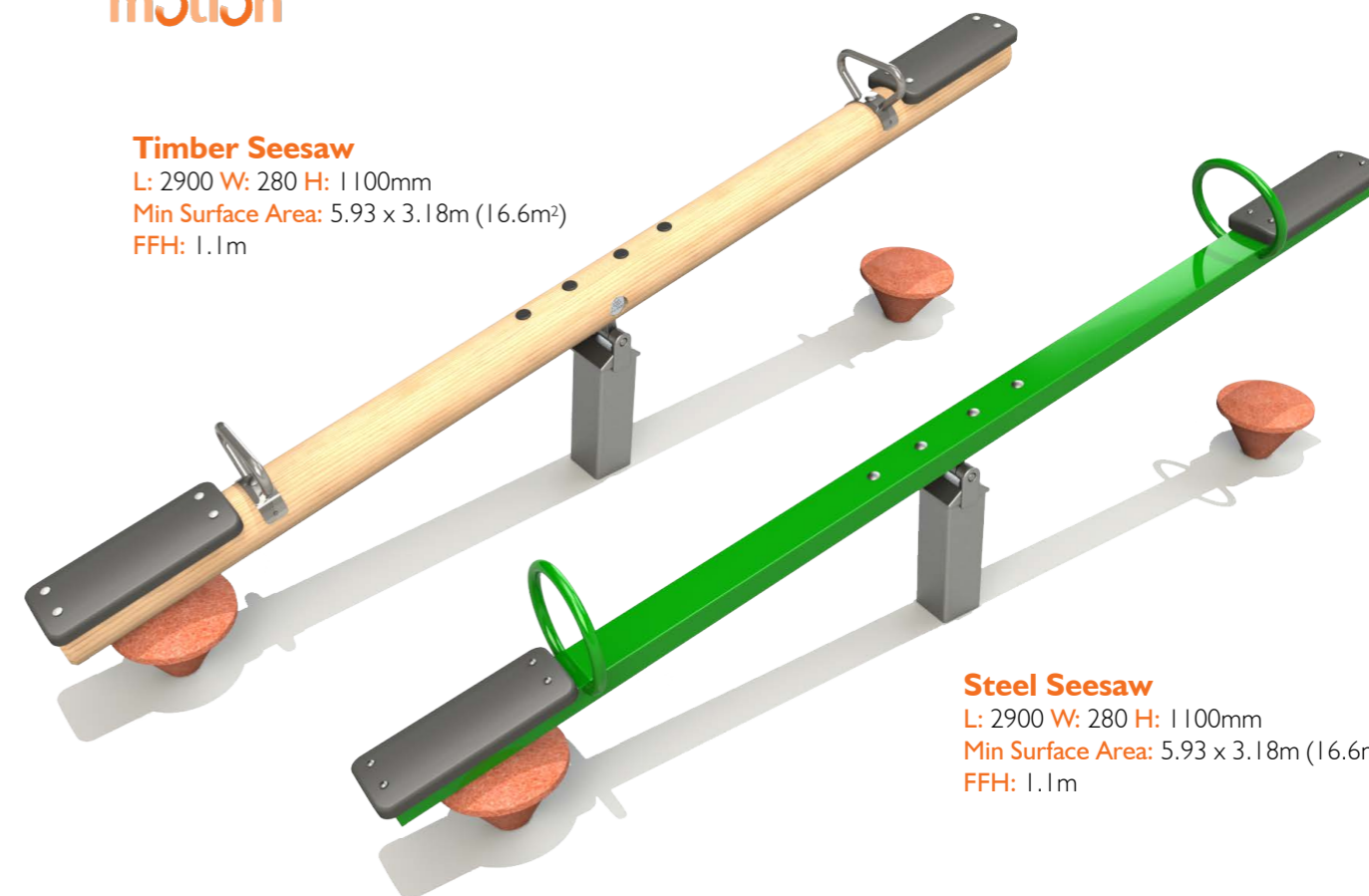

**Timber Seesaw**  
 L: 2900 W: 280 H: 1100mm  
 Min Surface Area: 5.93 x 3.18m (16.6m<sup>2</sup>)  
 FFH: 1.1m

**Steel Seesaw**  
 L: 2900 W: 280 H: 1100mm  
 Min Surface Area: 5.93 x 3.18m (16.6m<sup>2</sup>)  
 FFH: 1.1m

Embankment Slides

**Embankment Slides**  
 Platform Dimensions  
 L: 864 W: 614 H: 985mm

**Slide Heights**  
 1m, 1.25m, 1.5m & 2m

Different HDPE colours available on request.



Bespoke units available on request

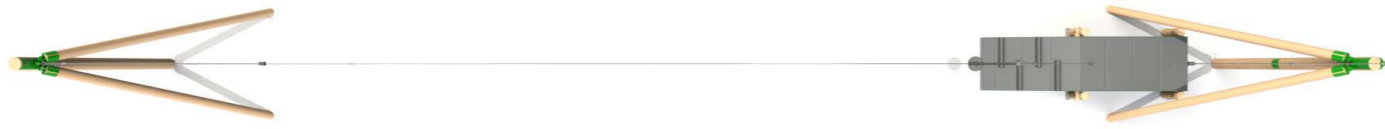

**One Way Timber - 30m**

L: 30000 W: 2100 H: 4100mm  
 Min Surface Area: 34 x 4m (132m<sup>2</sup>)  
 FFH: 1.25m

**One Way Timber - 25m**

L: 25000 W: 2100 H: 4100mm  
 Min Surface Area: 29 x 4m (112m<sup>2</sup>)  
 FFH: 1.25m

**One Way Timber - 20m**

L: 20000 W: 2100 H: 4100mm  
 Min Surface Area: 24 x 4m (92m<sup>2</sup>)  
 FFH: 1.25m

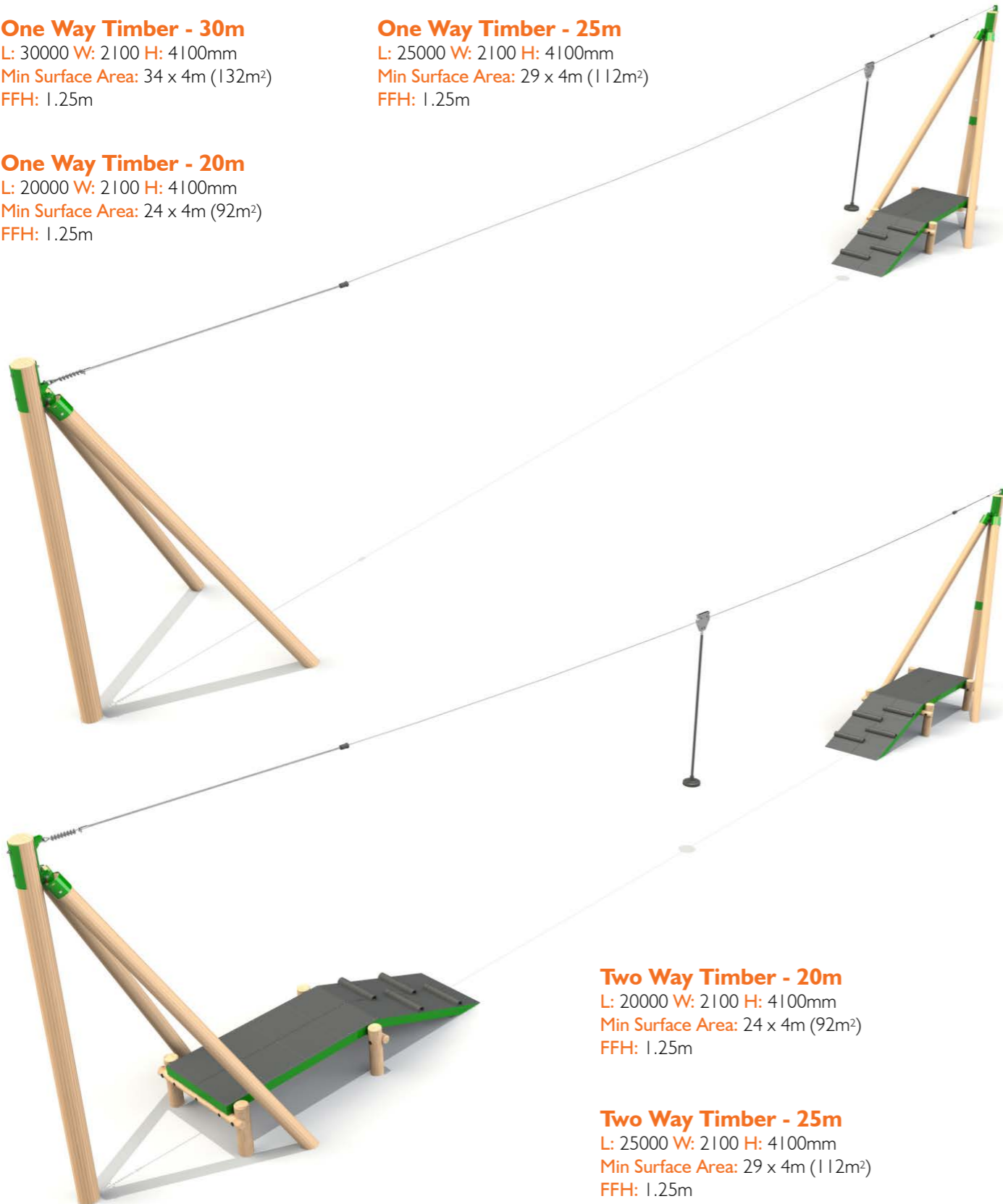

**Two Way Timber - 20m**

L: 20000 W: 2100 H: 4100mm  
 Min Surface Area: 24 x 4m (92m<sup>2</sup>)  
 FFH: 1.25m

**Two Way Timber - 25m**

L: 25000 W: 2100 H: 4100mm  
 Min Surface Area: 29 x 4m (112m<sup>2</sup>)  
 FFH: 1.25m

Other steel colours are available upon request

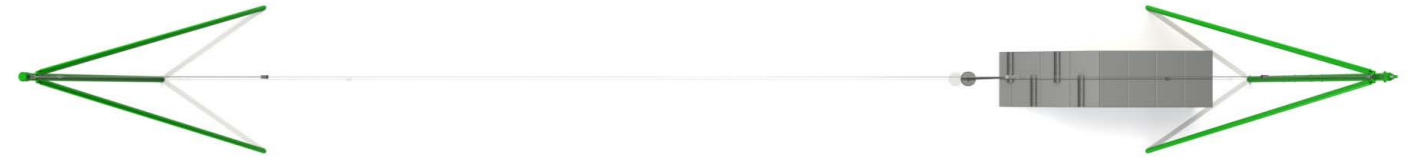

**One Way Steel - 25m**

L: 25000 W: 2100 H: 3550mm  
 Min Surface Area: 29 x 4m (112m<sup>2</sup>)  
 FFH: 1.25m

**One Way Steel - 30m**

L: 30000 W: 2100 H: 3550mm  
 Min Surface Area: 34 x 4m (132m<sup>2</sup>)  
 FFH: 1.25m

**One Way Steel - 20m**

L: 20000 W: 2100 H: 3550mm  
 Min Surface Area: 24 x 4m (92m<sup>2</sup>)  
 FFH: 1.25m

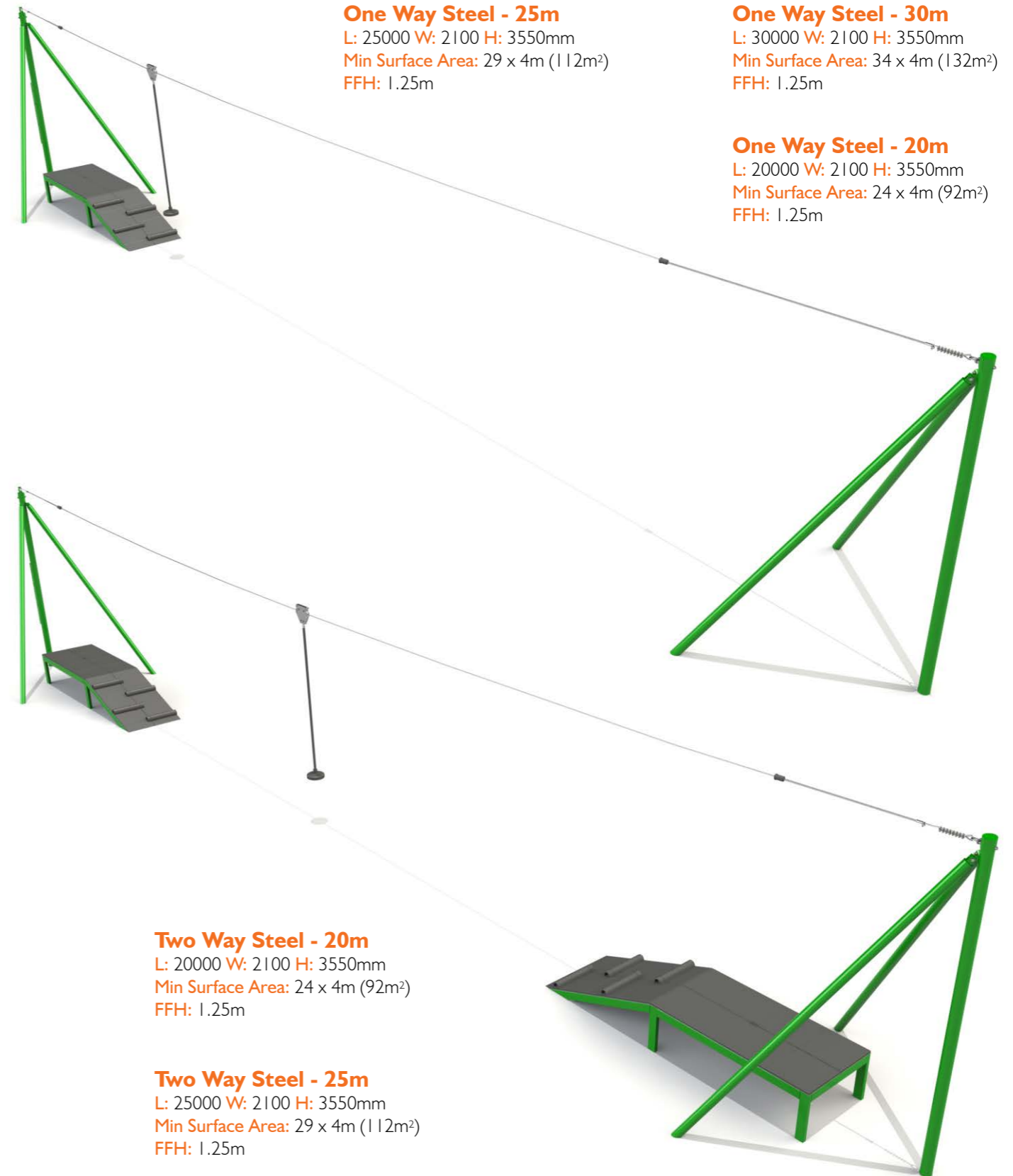

**Two Way Steel - 20m**

L: 20000 W: 2100 H: 3550mm  
 Min Surface Area: 24 x 4m (92m<sup>2</sup>)  
 FFH: 1.25m

**Two Way Steel - 25m**

L: 25000 W: 2100 H: 3550mm  
 Min Surface Area: 29 x 4m (112m<sup>2</sup>)  
 FFH: 1.25m

Bespoke units available on request



Established for over 50 years, A E Evans are the UK's market leader in the design and manufacture of timber based play equipment for supply directly to the trade. All products are designed and produced in the UK from sustainably sourced timber and can be FSC® certified (FSC® C102594) on request.

The ability to offer unrivalled value for money whilst still ensuring exceptional quality and longevity is key to A E Evans. The Play in Motion range accommodates all ages, budgets and play scheme

sizes. Our uncompromising approach to safety during the design and manufacturing process is paramount. With this in mind all the Play in Motion range are designed to meet the requirements of BS EN 1176.

In order to ensure the highest level of accuracy, all units are produced on our custom made, state of the art, 6 Axis CNC machine. This technology allows us to offer unparalleled accuracy in the field of play timber production.



Tel: 01978 710445

Email: [sales@aeevans.co.uk](mailto:sales@aeevans.co.uk)

[www.aeevans.co.uk](http://www.aeevans.co.uk)

A E Evans Ltd, Lightwood Green, Overton-on-Dee, Wrexham, LL13 0HU